

# TELEtek®

LED Aydınlatma Ürünleri LED Lighting Products

Dokunmatik Anahtar Touch Switch

LED Ampul LED Bulb



Catalogue L04-2020

Temiz enerji, Aydınlık gelecek  
Clean energy, Bright future



## Hakkımızda About Us

TELEtek, özgün ve yenilikçi tasarıma sahip tamamen Türkiye üretimi LED aydınlatma ürünlerinin geliştirme, üretim ve pazarlanmasında uzmanlaşmış olup kurulduğu 1974 yılından günümüze ülkemizin önde gelen elektrik-elektronik üreticilerindedir.

100% müşteri memnuniyetini hedefleyen satış politikası, geniş ürün çeşidi, stok kapasitesi, rekabetçi fiyat ve müşteri odaklı çözümler ile tüm Türkiye ve 25 ülkeye, yaygın satış kanallarımız aracılığıyla hizmet vermekteyiz.

Yaşam kalitesini yükseltecek LED teknolojisi tabanlı tasarım ve yenilikler; yoğun optik, elektronik ve mekanik mühendislik çalışmaları sonucu TELEtek Ar&Ge laboratuvarında geliştirilmektedir. Firmamızın almış olduğu patent ve tescilli tasarımlar yaratıcı ve yenilikçi yapımızın en önemli göstergesidir. CE ve RoHS yönetmeliklerine uyumlu TELEtek LED aydınlatma ürünleri, ISO 9001:2008 kalite yönetim sistemli modern üretim bantlarımızda üretilmektedir.

3000m2 kapalı alana sahip kendi binasında 50 kişilik deneyimli uzman kadrosu, tam otomatik SMD üretim bantları, otomasyon ağırlıklı üretim tesisi ve gelişmiş laboratuvarı ile TELEtek, güçlü bir yapıya sahiptir.

Hedefimiz, “Temiz enerji, Aydınlık gelecek” ilkesi ile Türkiye ve Avrupa pazarlarındaki başarımızı dünya pazarlarında da sürdürmektir.

TELEtek has been specialised in the development, production and marketing of innovative LED lighting products as being one of the leader electric-electronics manufacturers in Turkey since its establishment in 1974.

Targeting 100% customer satisfaction, we have been serving all over Turkey and to more than 25 countries with a wide range of products, stock capacity, competitive prices and customer-focused solutions.

Aiming to enhance the quality of life, LED based luminary designs and innovations are developed by the result of intensive optic, electronics and mechanical engineering studies at TELEtek R&D laboratory. Our in-depth R&D experience and know - how, that is protected by various worldwide patents and registered design certifications, mark our creative and innovative efforts. TELEtek LED luminaries which are in compliance with CE and RoHS standards are manufactured at state-of-the art manufacturing park in accordance with ISO 9001:2008 quality management system.

Located over 3000 sqm enclosed area in Istanbul, Turkey; TELEtek is a strong company thanks to its staff of more than 50 people, fully automated SMD lines, automated production lines and its modern R&D laboratory.

Being dedicated to ‘Clean energy, Bright future’ principle, our aim is to continue our strong growth all over the world as we have done at European markets.

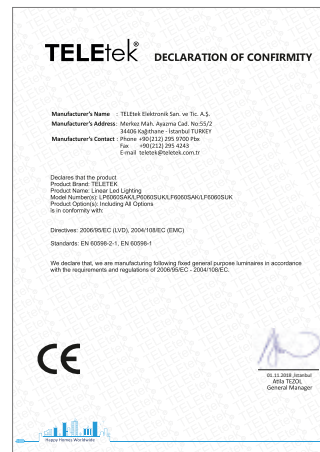

## İç Mekan Ürünler Indoor Products



5

Ampul  
Bulb

Dim Anahtar  
Dimmer Switch

5



6-7

Dokunmatik Anahtar  
Touch Switch

Etanj  
Etange

8



9

Yatay Bant  
Horizontal Band

Glob Backlight  
Globe Back-lit

10



11

Downlight Backlight  
Downlight Back-lit

Panel Backlight  
Panel Back-lit

12



13

İnce Panel Backlight  
Slim Panel Back-lit

Dekoratif Linear  
Decorative Linear

14



15

Dekoratif  
Decorative

Bant Işıldak, Mini Bant & Barisol  
Emergency Light, Mini Band & Barisol

16



17

Yüksek Tavan  
High-bay

## Dış Mekan Ürünler Outdoor Products



17

Yol & Sokak Aydınlatma  
Road & Street Light

Duvar Boyama  
Wallwasher

18



19

Sera Aydınlatma  
Greenhouse Light



yeni  
newLED Meşale Ampul  
LED Torch BulbLED Ampul  
LED BulbDim Anahtar  
Dimmer Switch

## Ürün Kodlama Product Coding

XX	65	6500K Soğuk Beyaz	6500K Cool White	Işık Rengi Color Temp.
40	4000K Gün Işığı	4000K Daylight		
30	3000K Sıcak Beyaz	3000K Warm White		

## LED Ampul LED Bulb

Ra&gt;80 220-240 Vac 50-60 Hz CE 2 Yıl Garanti



Kod Code	Güç Power	Işık Akısı Lumen	Duy Base	EBAT(çap*ıy)mm Dimensions(dia.*h)	Ad./Koli Pcs./Box	B. Fiyat U. Price
791.700.010.XX A60	PFC≈0,60	10W	850 lm	E27	Ø60x112	40 1,80 \$
791.700.P10.XX A60	PFC>0,95	10W	850 lm	E27	Ø60x112	40 \$
791.700.D10.XX A60 Dimlenebilir Dimmable	PFC>0,95	10W	850 lm	E27	Ø60x112	40 \$
792.700.013.XX A70	PFC≈0,60	13W	1100 lm	E27	Ø70x112	40 \$
792.700.P13.XX A70	PFC>0,95	13W	1100 lm	E27	Ø70x112	40 \$
792.700.D13.XX A70 Dimlenebilir Dimmable	PFC>0,95	13W	1100 lm	E27	Ø70x112	40 \$
793.700.040.XX Meşale Torch	PFC≈0,60	40W	3400 lm	E27	Ø120x220	20 \$
793.700.P40.XX Meşale Torch	PFC>0,95	40W	3400 lm	E27	Ø120x220	20 \$
793.700.D40.XX Meşale Dimlenebilir Torch Dimmable	PFC>0,95	40W	3400 lm	E27	Ø120x220	20 \$

Fiyat sorunuz  
Please ask for the price

Yalnız TELEtek® marka Dim Anahtar ile dimlenebilir. Dimmable only with TELEtek® branded dimmer.

## Ürün Özellikleri Product Features

- ▶ Standart ampüllerin PFC değerleri yaklaşık 0,57 olup, PFC değeri >0,95 olan TELEtek ampul ürünlerinin patent başvurusu yapılmıştır. Yüksek PFC, tesisattaki enerji kaybını azaltır, reaktif enerji bedeli oluşmaz, faturanıza yansımaz. Teknik açıklama için sayfa 21'ye bakınız.  
TELEtek patent pending LED bulb PFC value is > 0,95 while other conventional LED bulbs' PFC is 0,57 appr. High PFC value lowers the energy loss in the installation and avoids the reactive energy cost which enables you to have less-amount invoice. Please refer to page 21 for technical explanation.

- ▶ Işık açısı 240°dir. Beam angle is 240°.
- ▶ Gövde Hammadde Housing Material : ABS+Alüminum
- ▶ Optik Malzeme Optic Material : Polycarbon

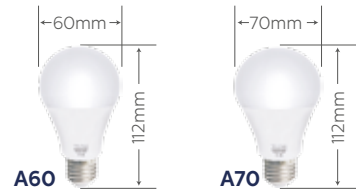

## Led Dim Anahtar Dimmer Switch

Kod Code	Güç Power	Ebat(b.xe.y)mm Dimensions(l.w.xh)	Ad./Koli Pcs./Box	B. Fiyat U. Price
639.00.001 Dim Anahtar Dimmer Switch	200W	800x800x48	24	12,00 \$

## Ürün Özellikleri Product Features

- ▶ Gövde Hammadde Housing Material : ABS
- ▶ Sadece TELEtek® LED aydınlatma ürünleri ile uyumlu çalışır.  
Works together in harmony with only TELEtek LED lighting products.

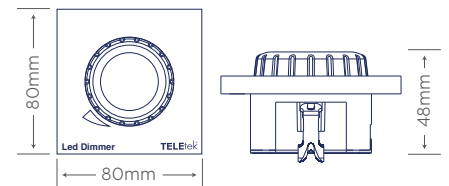

yeni  
new

## Dokunmatik Elektrik Anahtarı

### Touch Switch

Kod Code		Güç Power	Ebat(b.e.y)mm Dimensions(LxWxH)	Ad./Koli Pcs./Box	B. Fiyat U. Price
640.00.001	Dokunmatik Anahtar Tekli Touch Switch Single	200W	810x810x34	24	8,00 \$
640.00.002	Dokunmatik Anahtar İkili Touch Switch Twin	200W	810x810x34	24	15,50 \$
640.00.003	Dokunmatik Anahtar Üçlü Touch Switch Triple	200W	810x810x34	24	19,50 \$
640.00.005	Dokunmatik Anahtar Vavien Merkez Touch Switch Master	200W	810x810x34	24	13,50 \$
640.00.006	Dokunmatik Anahtar Vavien Şube Touch Switch Slave	200W	810x810x34	24	8,00 \$

### Ürün Özellikleri Product Features

- ▶ Nötr bağlantısı ve ilave kabloya ihtiyaç duymaz. *No need for neutral connection or extra cable*
- ▶ Mevcut sivaaltı/sıvaüstü anahtar yerine kolayca monte edilir. *Can be assembled flush-mount or wall-mount*
- ▶ Flamanlı, floresan, tasarruflu, LED lamba gibi tüm aydınlatma ürünlerinde sorunsuz çalışır. *Works well with all lighting products such as filament, fluorescent, energy-saving or LED bulbs*
- ▶ Kapasitif yarı iletken teknolojisi sayesinde kıvılcım oluşturmaz, gaz ihtiva eden tüm ortamlarda kullanıma uygundur. *Thanks to its capacitive semiconductor technology, no spark occurs inside*
- ▶ Şeffaf kapak içi resim ile kişiselleştirilebilir. *Can be personalized by photos inserted under the cover*
- ▶ Mekanik kontak içermez, uzun ömürlüdür. *Does not contain any mechanical switching mechanism, thus poses a longer service life*
- ▶ Yarı iletken (triyak) sigortalıdır. *With semiconductor (triac) fuse*
- ▶ Vavien şubelerde kalın bakır kablolar yerine zil teli kullanılır, tasarruf sağlar. *Vavien connentions save costs, no need for thick copper cables*
- ▶ Vidasız kablo bağlantısına sahiptir. *Fast push-on connection*
- ▶ Her çeşit kasaya uyan kompakt boyutlardadır. *Has compact sizes suitable for any plastic case*
- ▶ Gövde hammadde *Housing material ABS With semiconductor (triac) fuse: ABS*
- ▶ Optik malzeme *Optic material: Polystren*

### Teknik Özellikler Technical Features

- ▶ Maks. Yük *Max. load* : 250W
- ▶ Anma akımı *Rated current* : 1,0A
- ▶ Anma Gerilimi *Rated voltage* : 250V
- ▶ Çalışma Frekansı *Working frequency* : 50Hz
- ▶ Kablo Çapı *Cable diameter* : 1-1,5mm<sup>2</sup>

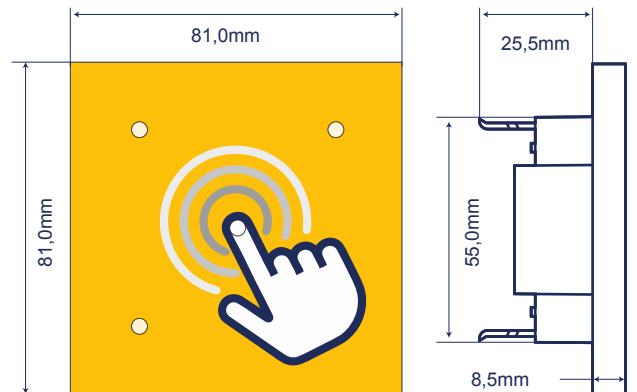



### Ürün Kişiselleştirme Personalization of the product

Sevdiğiniz fotoğraflarınızı yerleştirerek anahtarınızı kişiselleştirebilirsiniz.  
Personalization of the product is very easy, by inserting photos under the cover

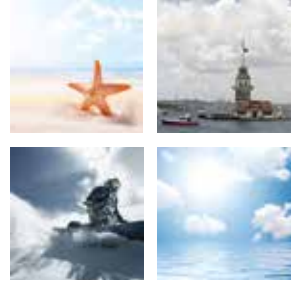

### Ürün Montajı Product Assembly

- ▶ Enerjiyi kesiniz, kablo bağlantısını yapınız.  
Cut the energy before starting any implementation on the product. Connect the cables
- ▶ Tırnak vidalarını sıkarak anahtarı sabitleyiniz.  
Fix the product by the screws located at two sides
- ▶ Şeffaf ürün kapağı içerisine resim koyunuz  
Place photo below transparent cover
- ▶ Ürün kapağını takınız.  
Place the transparent cover

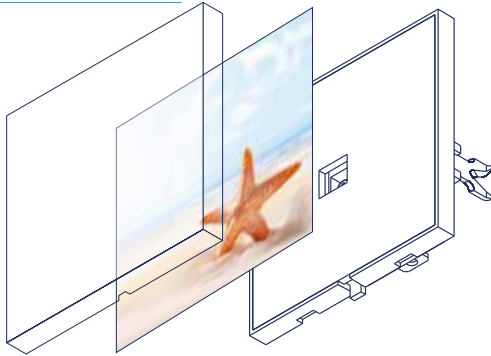

### Vavien Bağlantı Vavien Connection

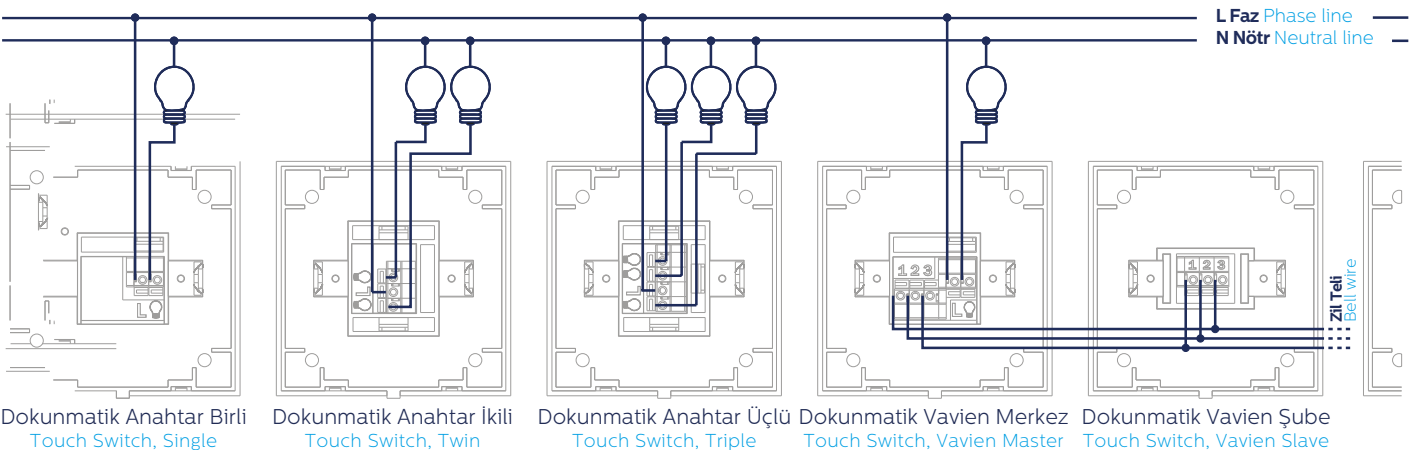

Dokunmatik Anahtar Birli  
Touch Switch, Single

Dokunmatik Anahtar İkili  
Touch Switch, Twin

Dokunmatik Anahtar Üçlü  
Touch Switch, Triple

Dokunmatik Vavien Merkez  
Touch Switch, Vavien Master

Dokunmatik Vavien Şube  
Touch Switch, Vavien Slave



## LED Etanj LED Etange

Ra&gt;80 220-240 Vac 50-60 Hz CE 2 Yıl Garanti

Kod Code	Güç Power	Işık Akısı Lumen	IP	Ebat(b.e.y)mm Dimensions(l.w.h)	Ad./Koli Pcs./Box	B. Fiyat U. Price
700.100.018.XX	18 W	1800 lm	65	600x50x50	24	14,00 \$
700.100.036.XX <b>Etanj</b>	36 W	3600 lm	65	1200x50x50	12	21,00 \$
700.100.044.XX <b>Etange</b>	44 W	4300 lm	65	1500x50x50	12	28,00 \$
700.100.048.XX	48 W	4700 lm	65	1800x50x50	12	31,00 \$
700.110.018.XX <b>Etanj Radar Hareket Sensörlü</b>	18 W	1800 lm	65	700x50x50	24	24,00 \$
700.110.036.XX <b>Etange with Radar Motion Sensor</b>	36 W	3600 lm	65	1300x50x50	12	32,00 \$
700.120.018.XX <b>Etanj Acil Durum Kitli</b>	18 W	1800 lm	65	700x50x50	24	39,00 \$
700.120.036.XX <b>Etange with Emergency Kit</b>	36 W	3600 lm	65	1300x50x50	12	46,00 \$
700.130.018.XX <b>Etanj Radar + Acil Durum Kitli</b>	18 W	1800 lm	65	750x50x50	24	48,00 \$
700.130.036.XX <b>Etange with Radar + Emergency Kit</b>	36 W	3600 lm	65	1350x50x50	12	56,00 \$
700.180.018.XX <b>Etanj Bant Koridor Fonksiyonlu</b>	18 W	1800 lm	65	700x50x50	24	24,00 \$
700.180.036.XX <b>Etange with Corridor Function</b>	36 W	3600 lm	65	1300x50x50	12	32,00 \$
700.190.018.XX <b>Etanj Koridor + Acil Durum Kitli</b>	18 W	1800 lm	65	750x50x50	24	48,00 \$
700.190.036.XX <b>Etange with Corridor + Emergency Kit</b>	36 W	3600 lm	65	1350x50x50	12	56,00 \$
701.100.028.XX <b>Etanj Geçişli</b>	28 W	2800 lm	65	1200x50x50	12	28,00 \$
<b>Etange Interconnectable</b>						

## Koridor Fonksiyon Corridor Function



## Ürün Kodlama Product Coding

B. Y. XX	65	40	30	0	P	D	0	1
	6500K Soğuk Beyaz	4000K Gün Işığı	3000K Sıcak Beyaz	PFC=0,60	PFC>0,95	PFC>0,95	Beyaz	Siyah
	6500K Cool White	4000K Daylight	3000K Warm White			Dimlenebilir Dimmable	White	Black
	-	-	-		4,00 \$	4,00 \$	-	2,00 \$

Yalnız TELEtek® marka Dim Anahtar ile dimlenebilir.  
Dimmable only with TELEtek® branded dimmer.

İlave B. Fiyat  
Extra U. Price

## Ürün Özellikleri Product Features

- PCB : Alüminyum Aluminum
- Gövde Hammadde Housing Material : Polycarbon
- Optik Malzeme Optic Material : Polycarbon
- İstenilen güçte, özel üretim yapılabilir.  
Special production is available upon required power specs.

Sensör Sensor	Hareket Algılama Alanı Movement Perception Area
Yükseklik Height	Çap Dia.
Radar	5m 10m

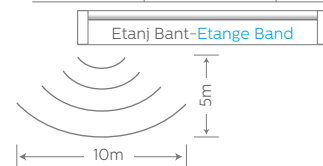





IP65 ve IP20 Koruma Sınıfı için sayfa 20 ye bakınız.  
Please refer to page 20 for IP65 and IP20 Rating.



## LED Yatay Bant LED Horizontal Band

Ra>80 220-240 Vac 50-60 Hz CE 2 Yıl Garanti

Kod Code	Güç Power	Işık Akısı Lumen	IP	Ebat(b.x.e.y)mm Dimensions(l.w.x.h)	Ad./Koli Pcs./Box	B. Fiyat U. Price
710.100.018.XX	18 W	1700 lm	20	600x75x30	24	11,00 \$
710.100.036.XX	36 W	3500 lm	20	1200x75x30	12	16,00 \$
710.100.044.XX	44 W	4200 lm	20	1500x75x30	12	26,00 \$
710.100.048.XX	48 W	4600 lm	20	1800x75x30	12	31,00 \$
710.110.018.XX	18 W	1700 lm	20	700x75x30	24	26,00 \$
710.110.036.XX	36 W	3500 lm	20	1300x75x30	12	32,00 \$
710.120.018.XX	18 W	1700 lm	20	700x75x30	24	39,00 \$
710.120.036.XX	36 W	3500 lm	20	1300x75x30	12	46,00 \$
710.130.018.XX	18 W	1700 lm	20	750x75x30	24	50,00 \$
710.130.036.XX	36 W	3500 lm	20	1350x75x30	12	58,00 \$
710.180.018.XX	18 W	1700 lm	20	700x75x30	24	26,00 \$
710.180.036.XX	36 W	3500 lm	20	1300x75x30	12	32,00 \$
710.190.018.XX	18 W	1700 lm	20	750x75x30	24	50,00 \$
710.190.036.XX	36 W	3500 lm	20	1350x75x30	12	58,00 \$
711.100.028.XX	28 W	2700 lm	20	1200x75x30	12	31,00 \$
712.100.018.XX	18 W	1700 lm	65	600x75x30	24	13,00 \$
712.100.036.XX	36 W	3500 lm	65	1200x75x30	12	18,00 \$
712.100.044.XX	44 W	4200 lm	65	1500x75x30	12	28,00 \$
712.100.048.XX	48 W	4600 lm	65	1800x75x30	12	31,00 \$

### Ürün Kodlama Product Coding

R	Y	XX			
65	6500K Soğuk Beyaz	6500K Cool White	-	Işık Rengi Color	
40	4000K Gün Işığı	4000K Daylight	-	Temperature	
30	3000K Sıcak Beyaz	3000K Warm White	-		
0	PFC≈0,60		-		
P	PFC>0,95		4,00 \$		yeni new
D	PFC>0,95	Dimlenebilir Dimmable	4,00 \$		
0	Beyaz	White	-	Gövde Rengi Finish Color	

Yalnız TELEtek® marka Dim Anahtar ile dimlenebilir.  
Dimmable only with TELEtek® branded dimmer.

İlave B. Fiyat  
Extra U. Price

### Ürün Özellikleri Product Features

- Gövde Hammadde Housing Material : Polycarbon
- Optik Malzeme Optic Material : Polycarbon

Sensör Sensor	Hareket Algılama Alanı Movement Perception Area	Yükseklik Height	Çap Dia.
Radar		5m	10m

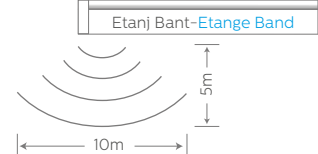

**Glob Pır Hareket Sensörlü, Beyaz**

 Glob w. Pır Motion Sensor, White  
**740.140.022.XX**
**Glob Antrasit**

 Glob, Antracite  
**740.102.022.XX**

**LED Glob Backlight** LED Globe Back-lit

Ra&gt;80 220-240 Vac 50-60 Hz CE 2 Yıl Garanti

Kod Code	Güç Power	Işık Akısı Lumen	IP	EBAT(çap*y)mm Dimensions(dia.*h)	Ad./Koli Pcs./Box	B. Fiyat U. Price
<b>SIVA ÜSTÜ SURFACE-MOUNTED</b>						
740.100.022.XX	<b>Glob</b>	22 W	2000 LM	20	Ø300x30	10 10,00 \$
740.110.022.XX	<b>Glob Radar Hareket Sensörlü</b> Glob with Radar Motion Sensor	22 W	2000 LM	20	Ø300x30	10 17,00 \$
740.120.022.XX	<b>Glob Acil Durum Kiti</b> Glob with Emergency Kit	22 W	2000 LM	20	Ø300x30	10 21,00 \$
740.130.022.XX	<b>Glob Radar + Acil Durum Kiti</b> Globe with Radar + Emergency Kit	22 W	2000 LM	20	Ø300x30	10 28,00 \$
740.140.022.XX	<b>Glob Pır Hareket Sensörlü</b> Glob with Pır Motion Sensor	22 W	2000 LM	20	Ø300x30	8 14,00 \$
740.150.022.XX	<b>Glob Pır + Acil Durum Kiti</b> Glob with Pır + Emergency Kit	22 W	2000 LM	20	Ø300x30	8 25,00 \$
740.100.D22.XX	<b>Glob Dimlenebilir</b> Globe Dimmable	22 W	2000 LM	20	Ø300x30	10 14,00 \$
740.120.D22.XX	<b>Glob Dimlenebilir + Acil Durum Kiti</b> Globe Dimmable Emergency Kit	22 W	2000 LM	20	Ø300x30	10 25,00 \$



Yalnız TELEtek® marka Dim Anahtar ile dimlenebilir. Dimmable only with TELEtek® branded dimmer.

**Ürün Kodlama Product Coding**



R.Y.XX	0	1	2	3	4
65	6500K Soğuk Beyaz	6500K Cool White	-	-	-
40	4000K Gün Işığı	4000K Daylight	-	-	-
30	3000K Sıcak Beyaz	3000K Warm White	-	-	-
0	<b>PFC ≈ 0,60</b>	-	-	-	-
P	<b>PFC &gt; 0,95</b>	-	4,00 \$	-	-
D	<b>PFC &gt; 0,95</b>	Dimlenebilir Dimmable	4,00 \$	-	-
0	Beyaz	White	-	-	-
1	Siyah	Black	2,00 \$	-	-
2	Antrasit	Antracite	2,00 \$	-	-
3	Gri	Gray	2,00 \$	-	-
4	Gri Çizgili	Gray Striped	2,00 \$	-	-

İlave B. Fiyat Extra U. Price

**Ürün Özellikleri Product Features**

- Gövde Hammadde Housing Material : ABS
- Optik Malzeme Optic Material : Polystren

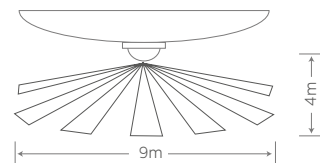
Sensör Sensor	Hareket Algılama Alanı Movement Perception Area	
	Yükseklik Height	Çap Dia.
Radar	5m	10m
Pır	4m	9m



8" Downlight, Beyaz  
8" Downlight, White  
751.200.018.XX

6" Downlight, Antrasit  
6" Downlight, Antracite  
750.202.013.XX

6" Downlight, Gri  
6" Downlight, Gray  
750.203.013.XX

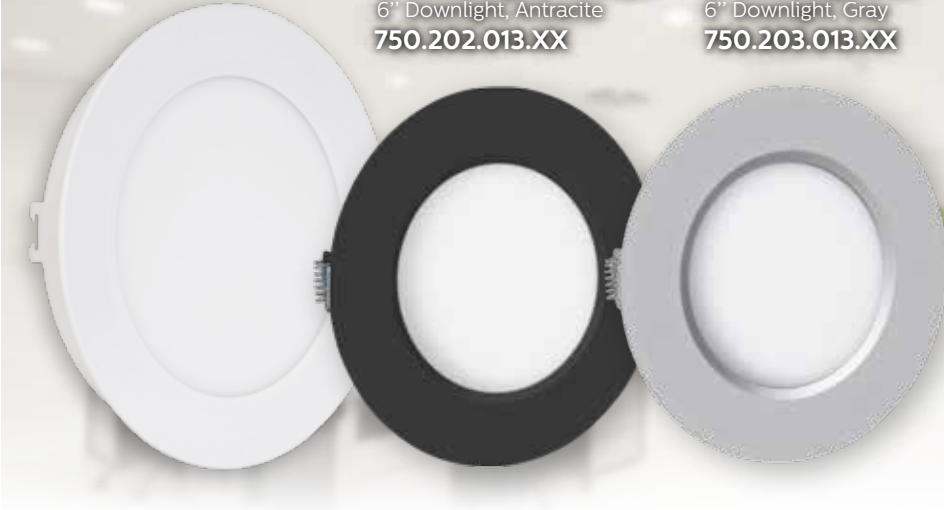

## LED Downlight Backlight LED Downlight Back-lit

Ra>80 220-240 Vac 50-60 Hz CE 2 Yıl Garanti



Kod Code	Güç Power	Işık Akısı Lumen	IP	EBAT(çap*y)mm Dimensions(dia.*h)	Ad./Koli Pcs./Box	B. Fiyat U. Price
<b>SIVA ALTI RECESSED</b>						
750.200.013.XX	DownLight 6"	13 W	1300 lm	20	Ø155x30	20 8,00 \$
750.210.013.XX	DownLight 6" Radar Hareket Sensörlü DownLight 6" with Radar Motion Sensor	13 W	1300 lm	20	Ø155x30	20 13,00 \$
750.220.013.XX	DownLight 6" Acil Durum Kiti DownLight 6" with Emergency Kit	13 W	1300 lm	20	Ø155x30	20 21,00 \$
750.230.013.XX	DownLight 6" Radar + Acil Durum Kiti DownLight 6" with Radar + Emergency Kit	13 W	1300 lm	20	Ø155x30	20 28,00 \$
750.200.D13.XX	DownLight 6" DownLight 6"	13 W	1300 lm	20	Ø155x30	20 12,00 \$
750.220.D13.XX	DownLight 6" Dimlenebilir + Acil Durum Kiti DownLight 6" Dimmable + Emergency Kit	13 W	1300 lm	20	Ø155x30	20 33,00 \$
751.200.018.XX	DownLight 8"	18 W	1750 lm	20	Ø200x30	20 10,00 \$
751.210.018.XX	DownLight 8" Radar Hareket Sensörlü DownLight 8" with Radar Motion Sensor	18 W	1750 lm	20	Ø200x30	20 16,00 \$
751.220.018.XX	DownLight 8" Acil Durum Kiti DownLight 8" with Emergency Kit	18 W	1750 lm	20	Ø200x30	20 21,00 \$
751.230.018.XX	DownLight 8" Radar + Acil Durum Kiti DownLight 8" with Radar + Emergency Kit	18 W	1750 lm	20	Ø200x30	20 28,00 \$
751.200.D18.XX	DownLight 8" Dimlenebilir DownLight 8" Dimmable	18 W	1750 lm	20	Ø200x30	20 14,00 \$
751.220.D18.XX	DownLight 8" Dimlenebilir + Acil Durum Kiti DownLight 8" Dimmable + Emergency Kit	18 W	1750 lm	20	Ø200x30	20 25,00 \$

Yalnız TELEtek® marka Dim Anahtar ile dimlenebilir. Dimmable only with TELEtek® branded dimmer.

### Ürün Kodlama Product Coding

R	Y	XX	0	1	2	3	4
65	6500K Soğuk Beyaz	6500K Cool White	-	-	-	-	-
40	4000K Gün Işığı	4000K Daylight	-	-	-	-	-
30	3000K Sıcak Beyaz	3000K Warm White	-	-	-	-	-
0	PFC ≈ 0,60	-	-	-	-	-	-
P	PFC > 0,95	-	4,00 \$	-	-	-	-
D	PFC > 0,95 Dimlenebilir Dimmable	-	4,00 \$	-	-	-	-
0	Beyaz	White	-	-	-	-	-
1	Siyah	Black	2,00 \$	-	-	-	-
2	Antrasit	Antracite	2,00 \$	-	-	-	-
3	Gri	Gray	2,00 \$	-	-	-	-
4	Gri Çizgili	Gray Striped	2,00 \$	-	-	-	-

İlave B. Fiyat Extra U. Price

### Ürün Özellikleri Product Features

- Gövde Hammadde Housing Material : ABS
- Optik Malzeme Optic Material : Polystren

Sensör Sensor	Hareket Algılama Alanı Movement Perception Area	
	Yükseklik Height	Çap Dia.
Radar	5m	10m
Pır	4m	9m

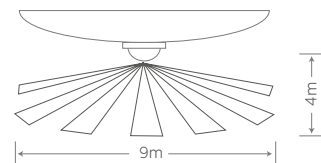



## LED Panel Backlight LED Panel Back-Lit

Ra>80 220-240 Vac 50-60 Hz CE 2 Yıl Garanti



Kod Code	Güç Power	Işık Akısı Lumen	IP	Ebat(bxexy)mm Dimensions(lxwxh)	Ad./Koli Pcs./Box	B. Fiyat U. Price
<b>60x60 SIVA ÜSTÜ SURFACE-MOUNTED</b>						
760.100.040.XX	Panel Panel	40 W	4000 LM	40	595x595x55	2 45,00 \$
760.110.040.XX	Panel Radar Hareket Sensörlü Slim Panel w. Radar Motion Sensor	40 W	4000 LM	40	595x595x55	2 55,00 \$
760.120.040.XX	Panel Acil Durum Kitli Panel w. Emergency Kit	40 W	4000 LM	40	595x595x55	2 67,00 \$
760.130.040.XX	Panel Radar + Acil Durum Kitli Panel w. Radar + Emergency Kit	40 W	4000 LM	40	595x595x55	2 79,00 \$
<b>60x60 SIVA ALTI RECESSED</b>						
760.200.040.XX	Panel Panel	40 W	4000 LM	40	595x595x55	2 38,00 \$
760.210.040.XX	Panel Radar Hareket Sensörlü Slim Panel w. Radar Motion Sensor	40 W	4000 LM	40	595x595x55	2 48,00 \$
760.220.040.XX	Panel Acil Durum Kitli Panel w. Emergency Kit	40 W	4000 LM	40	595x595x55	2 60,00 \$
760.230.040.XX	Panel Radar + Acil Durum Kitli Panel w. Radar + Emergency Kit	40 W	4000 LM	40	595x595x55	2 72,00 \$
<b>60x60 ALÇIPAN TAVAN KLİPSLİ W. DROP CEILING CLIPS</b>						
760.300.040.XX	Panel Panel	40 W	4000 LM	40	595x595x55	2 45,00 \$
760.310.040.XX	Panel Radar Hareket Sensörlü Slim Panel w. Radar Motion Sensor	40 W	4000 LM	40	595x595x55	2 55,00 \$
760.320.040.XX	Panel Acil Durum Kitli Panel w. Emergency Kit	40 W	4000 LM	40	595x595x55	2 67,00 \$
760.330.040.XX	Panel Radar + Acil Durum Kitli Panel w. Radar + Emergency Kit	40 W	4000 LM	40	595x595x55	2 79,00 \$
<b>60x60 KLİP-İN CLIP-IN</b>						
760.400.040.XX	Panel Panel	40 W	4000 LM	40	595x595x55	2 51,00 \$
760.410.040.XX	Panel Radar Hareket Sensörlü Slim Panel w. Radar Motion Sensor	40 W	4000 LM	40	595x595x55	2 61,00 \$
760.420.040.XX	Panel Acil Durum Kitli Panel w. Emergency Kit	40 W	4000 LM	40	595x595x55	2 73,00 \$
760.430.040.XX	Panel Radar + Acil Durum Kitli Panel w. Radar + Emergency Kit	40 W	4000 LM	40	595x595x55	2 85,00 \$

### Ürün Kodlama Product Coding

B, Y	XX	0	P	D	0
65	6500K Soğuk Beyaz	6500K Cool White	-	-	-
40	4000K Gün Işığı	4000K Daylight	-	-	-
30	3000K Sıcak Beyaz	3000K Warm White	-	-	-
0	PFC ≈ 0,60	-	-	-	-
P	PFC > 0,95	4,00 \$	yeni new	-	-
D	PFC > 0,95 Dimlenebilir Dimmable	4,00 \$	-	-	-
0	Beyaz	White	-	-	-

Yalnız TELEtek® marka Dim Anahtar ile dimlenebilir.  
Dimmable only with TELEtek® branded dimmer.

İlave B. Fiyat  
Extra U. Price

### Ürün Özellikleri Product Features

- Gövde Hammadde Housing Material : ABS
- Optik Malzeme Optic Material : Polystren

Sensör Sensor	Hareket Algılama Alanı Movement Perception Area	
	Yükseklik Height	Çap Dia.
Radar	5m	10m

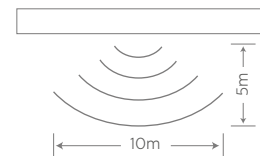



60x60 Beyaz, White  
760.500.048.XX

30x60 Gri Çizgili, Gray Striped  
761.504.048.XX

30x30 Siyah, Black  
762.501.036.XX

## LED İnce Panel Backlight LED Slim Panel Back-Lit



Ra>80 220-240 Vac 50-60 Hz CE 2 Yıl Garanti

Kod Code	Güç Power	Işık Akısı Lumen	IP	Ebat(bxexy)mm Dimensions(lxwxh)	Ad./Koli Pcs./Box	B. Fiyat U. Price
<b>60x60 SIVAÜSTÜ + TAŞYÜNÜ SURFACE-MOUNTED + STONE WOOL</b>						
760.500.048.XX	48 W	5280 lm	20	595x595x38	4	42,00 \$
760.500.D48.XX	48 W	5280 lm	20	595x595x38	4	46,00 \$
760.510.048.XX	48 W	5280 lm	20	595x595x38	4	53,00 \$
760.520.048.XX	48 W	5280 lm	20	595x595x38	4	62,00 \$
760.530.048.XX	48 W	5280 lm	20	595x595x38	4	72,00 \$
<b>30x60 SIVAÜSTÜ + TAŞYÜNÜ SURFACE-MOUNTED + STONE WOOL</b>						
761.500.048.XX	48 W	5280 lm	20	295x595x30	8	30,00 \$
761.500.D48.XX	48 W	5280 lm	20	295x595x30	8	34,00 \$
761.510.048.XX	48 W	5280 lm	20	295x595x30	8	38,00 \$
761.520.048.XX	48 W	5280 lm	20	295x595x30	8	50,00 \$
761.530.048.XX	48 W	5280 lm	20	295x595x30	8	60,00 \$
<b>30x30 SIVAÜSTÜ + TAŞYÜNÜ SURFACE-MOUNTED + STONE WOOL</b>						
762.500.036.XX	36 W	3960 lm	20	295x295x30	8	22,00 \$
762.500.D36.XX	36 W	3960 lm	20	295x295x30	8	26,00 \$
762.510.036.XX	36 W	3960 lm	20	295x295x30	8	30,00 \$
762.520.036.XX	36 W	3960 lm	20	295x295x30	8	42,00 \$
762.530.036.XX	36 W	3960 lm	20	295x295x30	8	52,00 \$



Yalnız TELEtek® marka Dim Anahtar ile dimlenebilir. Dimmable only with TELEtek® branded dimmer.

### Ürün Kodlama Product Coding

R, Y	XX	0	1	2	3	4
65	6500K Soğuk Beyaz	6500K Cool White	-	-	-	-
40	4000K Gün Işığı	4000K Daylight	-	-	-	-
30	3000K Sıcak Beyaz	3000K Warm White	-	-	-	-
0	PFC > 0,60	-	-	-	-	-
P	PFC > 0,95	-	4,00 \$	-	-	-
D	PFC > 0,95 Dimlenebilir Dimmable	-	4,00 \$	-	-	-
0	Beyaz	White	-	-	-	-
1	Siyah	Black	3,00 \$	-	-	-
2	Antrasit	Antracite	3,00 \$	-	-	-
3	Gri	Gray	3,00 \$	-	-	-
4	Gri Çizgili	Gray Striped	3,00 \$	-	-	-

İlave B. Fiyat Extra U. Price

### Ürün Özellikleri Product Features

- Gövde Hammadde Housing Material : ABS
- Optik Malzeme Optic Material : Polystren
- İstenilen güçte, özel üretim yapılabilir. Special production is available upon required power specs.

Sensör Sensor	Hareket Algılama Alanı Movement Perception Area	
	Yükseklik Height	Çap Dia.
Radar	5m	10m

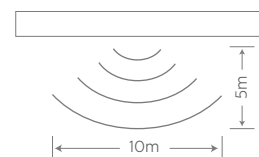



## LED Dekoratif Linear LED Decorative Linear

Ra>80 220-240 Vac 50-60 Hz CE 2 Yıl Garanti

Kod Code	Güç Power	Işık Akısı Lumen	IP	Ebat(b.e.y)mm Dimensions(l.w.h)	Ad./Koli Pcs./Box	B. Fiyat U. Price
<b>SARKIT PENDANT</b>						
770.600.018.XX	18 W	1600 LM	40		1	\$
770.600.027.XX	27 W	2400 LM	40		1	\$
770.600.036.XX	36 W	3200 LM	40		1	\$
771.600.018.XX	18 W	1600 LM	40		1	\$
771.600.027.XX	27 W	2400 LM	40		1	\$
771.600.036.XX	36 W	3200 LM	40		1	\$
772.600.018.XX	18 W	1600 LM	40		1	\$
772.600.027.XX	27 W	2400 LM	40		1	\$
772.600.036.XX	36 W	3200 LM	40		1	\$
<b>SARKIT SIVA ÜSTÜ SURFACE-MOUNTED</b>						
770.100.018.XX	18 W	1600 LM	40		1	\$
770.100.027.XX	27 W	2400 LM	40		1	\$
770.100.036.XX	36 W	3200 LM	40		1	\$
771.100.018.XX	18 W	1600 LM	40		1	\$
771.100.027.XX	27 W	2400 LM	40		1	\$
771.100.036.XX	36 W	3200 LM	40		1	\$
772.100.018.XX	18 W	1600 LM	40		1	\$
772.100.027.XX	27 W	2400 LM	40		1	\$
772.100.036.XX	36 W	3200 LM	40		1	\$
<b>SARKIT SIVA ALTI RECESSED</b>						
770.200.018.XX	18 W	1600 LM	40		1	\$
770.200.027.XX	27 W	2400 LM	40		1	\$
770.200.036.XX	36 W	3200 LM	40		1	\$
771.200.018.XX	18 W	1600 LM	40		1	\$
771.200.027.XX	27 W	2400 LM	40		1	\$
771.200.036.XX	36 W	3200 LM	40		1	\$
772.200.018.XX	18 W	1600 LM	40		1	\$
772.200.027.XX	27 W	2400 LM	40		1	\$
772.200.036.XX	36 W	3200 LM	40		1	\$

İstenilen profil ölçü, ürün ebat, opsiyonel elektrik kit ve ışık renklerinde üretilir. Manufactured at required profile dimensions, product sizes, optional electric kit and light colors.

Sipariş bazlı fiyat verilir Price quoted upon collection of order

### Ürün Kodlama Product Coding

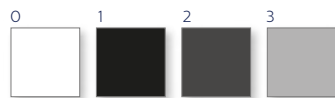

R. Y.	XX	65	40	30
		6500K Soğuk Beyaz	4000K Gün Işığı	3000K Sıcak Beyaz
		6500K Cool White	4000K Daylight	3000K Warm White
		0 Beyaz	1 Siyah	2 Antrasit
				3 Gri

Işık Rengi  
Color  
Temperature

Gövde Rengi  
Finish Color

### Ürün Özellikleri Product Features

- ▶ Gövde : Elektrostatik Toz Boyalı Alüminyum Ekstrüzyon Gövde  
Housing Material : Electrostatic-Powder-Painted Aluminum Extrusion Body
- ▶ Gövde renk : RAL renkleri Housing color : RAL colors
- ▶ Optik Malzeme : Yüksek Geçirgenlikli Opal Difüzör  
Optic Material : High-Transmissive Opal Diffuser
- ▶ Opsiyonel Kit : 1-10V Dali-Dim, Koridor Fonksiyon, 1-3 saat Acil Aydınlatma  
Optional Kit : 1-10V Dali-Dim, Corridor Function, 1-3hrs Emergency

Linear Model Profil ölçüsü Linear Model Profile Dimensions	Montaj Assembly	Yükseklik Height (mm)	Genişlik Width (mm)
Bant Band	Sarkit & Sıvaüstü Çember Circle Pendant & Surface-Mounted	75, 85	30, 50, 53, 66, 87
Çember Circle		45, 70, 80, 100, 120	
Kare Square		75, 85	50, 53, 66, 89
Bant Band	Sıvaaltı Recessed	80, 100, 120	
Çember Circle		80, 100, 120	
Kare Square		80, 100, 120	



**Sarkıt Daire**  
Pendant Round

**Sıva Üstü Daire**  
Surface Mounted Round

**Sarkıt Altıgen**  
Pendant Hexagon

## LED Dekoratif LED Decorative



Ra>80 220-240 Vac 50-60 Hz CE 2 Yıl Garanti

Kod Code	Güç Power	Işık Akısı Lumen	IP	Ebat(dış çap.y)mm Dim.(outer dia.h)	Ad./Koli Pcs./Box	B. Fiyat U. Price	
<b>SARKIT PENDANT</b>							
776.600.060.XX	60 W	5400 LM	40	İstenilen profil ölçü, ürün ebat, opsiyonel elektrik kit ve ışık renklerinde üretilir. Manufactured at required profile dimensions, product sizes, optional electric kit and light colors.	1	\$	
776.600.090.XX	90 W	8000 LM	40		1	\$	
777.600.060.XX	60 W	5400 LM	40		1	\$	
777.600.090.XX	90 W	8000 LM	40		1	\$	
778.600.060.XX	60 W	5400 LM	40		1	\$	
778.600.090.XX	90 W	8000 LM	40		1	\$	
<b>SIVA ÜSTÜ SURFACE-MOUNTED</b>							
776.100.060.XX	60 W	5400 LM	40		1	Sipariş bazlı fiyat verilir	\$
776.100.090.XX	90 W	8000 LM	40		1	Price quoted upon collection of order	\$
777.100.060.XX	60 W	5400 LM	40		1	\$	
777.100.090.XX	90 W	8000 LM	40		1	\$	
778.100.060.XX	60 W	5400 LM	40		1	\$	
778.100.090.XX	90 W	8000 LM	40	1	\$		
<b>SIVA ALTI RECESSED</b>							
776.200.060.XX	60 W	5400 LM	40	1	\$		
776.200.090.XX	90 W	8000 LM	40	1	\$		
777.200.060.XX	60 W	5400 LM	40	1	\$		
777.200.090.XX	90 W	8000 LM	40	1	\$		
778.200.060.XX	60 W	5400 LM	40	1	\$		
778.200.090.XX	90 W	8000 LM	40	1	\$		

### Ürün Kodlama Product Coding

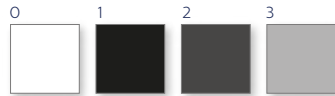

R. Y.	XX	0	1	2	3	İşık Rengi Color Temperature	Gövde Rengi Finish Color
65	6500K Soğuk Beyaz	White	Black	Antracite	Gri	6500K Cool White	
40	4000K Gün Işığı	White	Black	Antracite	Gri	4000K Daylight	
30	3000K Sıcak Beyaz	White	Black	Antracite	Gri	3000K Warm White	

### Ürün Özellikleri Product Features

- Gövde : Elektrostatik Toz Boyalı Alüminyum Ekstrüzyon Gövde  
Housing Material : Electrostatic-Powder-Painted Aluminum Extrusion Body
- Gövde renk : RAL renkleri Housing color : RAL colors
- Optik Malzeme : Yüksek Geçirgenlikli Opal Difüzör  
Optic Material : High-Transmissive Opal Diffuser
- Opsiyonel Kit : 1-10V Dali-Dim, Koridor Fonksiyon, 1-3 saat Acil Aydınlatma  
Optional Kit : 1-10V Dali-Dim, Corridor Function, 1-3hrs Emergency

Lineer Model Profil ölçüsü Linear Model Profile Dimensions	Montaj Assembly	Yükseklik Height (mm)	Genişlik Width (mm)
Bant Band	Sarkıt & Sıvaüstü Pendant & Surface-Mounted	75, 85	30, 50, 53, 66, 87
Çember Circle		45, 70, 80, 100, 120	
Kare Square		75, 85	50, 53, 66, 89
Bant Band	Sıvaaltı Recessed	80, 100, 120	
Çember Circle		80, 100, 120	
Kare Square		80, 100, 120	



## LED Işıldak Emergency Light

Ra>80 220-240 Vac 50-60 Hz CE 2 Yıl Garanti



Kod Code	Güç Power	Işık Akısı Lumen	IP	Ebat(b.e.y)mm Dimensions(l.w.x.h)	Ad./Koli Pcs./Box	B. Fiyat U. Price	
709.100.012.XX	<b>Bant Işıldak</b> Band Emergency Light	12W	1800 LM	65	700x50x50	24	<b>45,00 \$</b>

### Ürün Özellikleri Product Features

- ▶ Gövde Hammadde **Housing Material** : Polycarbon
- ▶ Optik Malzeme **Optic Material** : Polycarbon

## LED Mini Bant LED Mini Band

Kod Code	Güç Power	Işık Akısı Lumen	IP	Ebat(b.e.y)mm Dimensions(l.w.x.h)	Ad./Koli Pcs./Box	B. Fiyat U. Price	
736.100.009.XX	<b>Mini Bant Anahtarlı</b>	9W	850 LM	20	600x26x28	24	<b>9,00 \$</b>
736.100.018.XX	<b>Mini Band with Switch</b>	18W	1750 LM	20	1200x26x28	24	<b>12,00 \$</b>
737.100.009.XX	<b>Mini Bant</b>	9W	850 LM	20	600x26x28	24	<b>8,00 \$</b>
737.100.018.XX	<b>Mini Band</b>	18W	1750 LM	20	1200x26x28	24	<b>11,00 \$</b>

### Ürün Özellikleri Product Features

- ▶ Gövde Hammadde **Housing Material** : Polycarbon
- ▶ Optik Malzeme **Optic Material** : Polycarbon

## LED Barisol LED Barisol

Kod Code	Güç Power	Işık Akısı Lumen	IP	Ebat(b.e.y)mm Dimensions(l.w.x.h)	Ad./Koli Pcs./Box	B. Fiyat U. Price	
<b>Gerilim Voltage : 12 Vdc</b>							
738.000.008.XX	<b>48 Led</b>	8W	1200 LM/m	-	500x16x1,6	10	<b>3,90 \$</b>
738.000.012.XX	<b>60 Led</b>	12W	1500 LM/m	-	500x16x1,6	10	<b>4,30 \$</b>
738.000.024.XX	<b>120 Led</b>	24W	3000 LM/m	-	500x16x1,6	10	<b>5,90 \$</b>
<b>Gerilim Voltage : 24 Vdc</b>							
739.000.008.XX	<b>48 Led</b>	8W	1200 LM/m	-	500x16x1,6	10	<b>3,90 \$</b>
739.000.012.XX	<b>60 Led</b>	12W	1500 LM/m	-	500x16x1,6	10	<b>4,30 \$</b>
739.000.024.XX	<b>120 Led</b>	24W	3000 LM/m	-	500x16x1,6	10	<b>5,90 \$</b>

### Ürün Kodlama Product Coding

XX	65	40	30	Işık Rengi Color Temperature
	6500K Soğuk Beyaz	4000K Gün Işığı	3000K Sıcak Beyaz	6500K Cool White
				4000K Daylight
				3000K Warm White

### Ürün Özellikleri Product Features

- ▶ Gövde Hammadde **Housing Material** : Metal
- ▶ Optik Malzeme **Optic Material** : Polycarbon





## LED Yüksek Tavan LED High-bay



Ra>80 90-240 Vac 50-60 Hz PFC >0,90 CE 2 Yıl Garanti

Kod Code	Güç Power	Işık Akısı Lumen	DUY	Ebat(b.e.y)mm Dimensions(l.w.xh)	Ad./Koli Pcs./Box	B. Fiyat U. Price
781.100.060.XX	60 W	6300 LM	65	300x150x170	1	150,00 \$
781.100.080.XX	80 W	8400 LM	65	300x150x180	1	170,00 \$
781.100.100.XX	100 W	10500 LM	65	300x150x190	1	212,00 \$
781.100.120.XX	120 W	12600 LM	65	300x150x200	1	284,00 \$
781.100.160.XX	160 W	16000 LM	65	300x150x220	1	350,00 \$

### Ürün Kodlama Product Coding

XX	65	40	30	Işık Rengi Color Temperature
65	6500K Soğuk Beyaz	6500K Cool White		
40	4000K Gün Işığı	4000K Daylight		
30	3000K Sıcak Beyaz	3000K Warm White		

### Ürün Özellikleri Product Features

- Gövde Hammadde Housing Material : Metal
- Optik Malzeme Optic Material : Polycarbon
- Çıkış açısı Output angle : 50°x 150°

## LED Yol & Sokak Aydınlatma Road & Street Light

Ra>80 90-240 Vac 50-60 Hz PFC >0,90 CE 2 Yıl Garanti

Kod Code	Güç Power	Işık Akısı Lumen	IP	Ebat(b.e.y)mm Dimensions(l.w.xh)	Ad./Koli Pcs./Box	B. Fiyat U. Price
783.000.050.XX	50 W	5750 LM	65	280x100x220	1	151,00 \$
783.000.100.XX	100 W	11500 LM	65	280x100x300	1	285,00 \$
783.000.150.XX	150 W	17250 LM	65	280x100x380	1	379,00 \$
783.000.200.XX	200 W	23000 LM	65	280x100x460	1	529,00 \$

### Ürün Kodlama Product Coding

XX	65	40	30	Işık Rengi Color Temperature
65	6500K Soğuk Beyaz	6500K Cool White		
40	4000K Gün Işığı	4000K Daylight		
30	3000K Sıcak Beyaz	3000K Warm White		

### Ürün Özellikleri Product Features

- Gövde Hammadde Housing Material : Metal
- Optik Malzeme Optic Material : Polycarbon
- Çıkış açısı Output angle : 50°x 150°



## LED Duvar Boyama LED Wallwasher



Ra>80 220-240 Vac 50-60 Hz CE 2 Yıl Garanti

Kod Code	Güç Power	Işık Akısı Lumen	IP	Ebat(b.e.y)mm Dimensions(l.w.xh)	Ad./Koli Pcs./Box	B. Fiyat U. Price
784.101.009.XX	9W	900 LM	67	300x50x50	8	28,00 \$
784.101.015.XX	15W	1500 LM	67	500x50x50	8	35,00 \$
784.101.018.XX	18W	1800 LM	67	600x50x50	8	39,00 \$
784.101.030.XX	30W	3000 LM	67	1000x50x50	8	57,00 \$
784.101.036.XX	36W	3600 LM	67	1200x50x50	8	66,00 \$
785.101.009.XX	9W	855 LM	67	300x50x50	8	36,00 \$
785.101.015.XX	15W	1425 LM	67	500x50x50	8	46,00 \$
785.101.018.XX	18W	1710 LM	67	600x50x50	8	51,00 \$
785.101.030.XX	30W	2850 LM	67	1000x50x50	8	75,00 \$
785.101.036.XX	36W	3420 LM	67	1200x50x50	8	86,00 \$

### Ürün Kodlama Product Coding

Y	XX	65	6500K Soğuk Beyaz	6500K Cool White	-	Işık Rengi Color Temperature
		40	4000K Gün Işığı	4000K Daylight	-	
		30	3000K Sıcak Beyaz	3000K Warm White	-	
		01	Kırmızı	Red	-	
		02	Mavi	Blue	-	
		03	Yeşil	Green	-	
		04	Amber	Amber	-	
		0	PFC ≈ 0,60	-	-	yeni new
		P	PFC > 0,95	-	4,00 \$	
		D	PFC > 0,95	Dimlenebilir Dimmable	4,00 \$	



Yalnız TELEtek® marka Dim Anahtar ile dimlenebilir.  
Dimmable only with TELEtek® branded dimmer.

İlave B. Fiyat  
Extra U. Price

### Ürün Özellikleri Product Features

- ▶ Gövde Hammaddesi Housing Material : Polycarbon
- ▶ Optik Malzeme Optic Material : Polycarbon
- ▶ Çıkış açısı Output angle : 90°x 90°



## LED Sera Aydınlatma LED Greenhouse Light

Flicker Free 180-240 Vac 50-60 Hz CE 2 Yıl Garanti

Kod Code	Güç Power	Işık Akısı Lumen	IP	Ebat(b.e.y)mm Dimensions(l.w.xh)	Ad./Koli Pcs./Box	B. Fiyat U. Price		
<b>Çilek, Domates, Biber, Patlıcan</b> Strawberry, Tomato, Pepper, Eggplants								
788.100.028.71	7 Kırmızı 1 Mavi	7 Red 1 Blue	28W	-	65	1200x75x30	12	27,00 \$
789.100.028.71	7 Kırmızı 1 Mavi, Geçişli	7 Red 1 Blue, interconnectable	28W	-	65	1200x75x30	12	33,00 \$
<b>Kesme Çiçek ve Saksı Bitkileri</b> Cut Flowers and Pot Plants								
788.100.028.31	3 Kırmızı 1 Mavi	3 Red 1 Blue	28W	-	65	1200x75x30	12	27,00 \$
789.100.028.31	3 Kırmızı 1 Mavi, Geçişli	3 Red 1 Blue, interconnectable	28W	-	65	1200x75x30	12	33,00 \$
<b>Etlü Yapraklı Bitkiler</b> Fleshy Leafy Plants ( Cactus, Aloe Vera )								
788.100.028.51	5 Kırmızı 1 Mavi	5 Red 1 Blue	28W	-	65	1200x75x30	12	27,00 \$
789.100.028.51	5 Kırmızı 1 Mavi, Geçişli	5 Red 1 Blue, interconnectable	28W	-	65	1200x75x30	12	33,00 \$

### Ürün Kodlama Product Coding

Y	XX	65	6500K Soğuk Beyaz	6500K Cool White	-	Işık Rengi Color Temperature
		40	4000K Gün Işığı	4000K Daylight	-	
		30	3000K Sıcak Beyaz	3000K Warm White	-	
		01	Kırmızı	Red	-	
		02	Mavi	Blue	-	
		03	Yeşil	Green	-	
		04	Amber	Amber	-	
		0	PFC ≈ 0,60	-	-	yeni new
		P	PFC > 0,95	-	4,00 \$	
		D	PFC > 0,95	Dimlenebilir Dimmable	4,00 \$	

Yalnız TELEtek® marka Dim Anahtar ile dimlenebilir.  
Dimmable only with TELEtek® branded dimmer.

İlave B. Fiyat  
Extra U. Price

### Ürün Özellikleri Product Features

- ▶ Gövde Hammadde Housing Material : Polycarbon
- ▶ Optik Malzeme Optic Material : Polycarbon

# IP Koruma Sınıfı IP Ratings

IP (veya "Ingress Koruma") sınıfı, uluslararası EN 60529 ( İngiltere BS EN 60529:1992, Avrupa IEC 60509:1989 ) standartlarında tanımlanmıştır. IP derecelendirmesi iki sayıdan oluşur. İlk sayı katı cisimlere karşı koruma, ikinci sayı ise sıvılara karşı koruma derecesini ifade eder

IP (or "Ingress Protection") ratings are defined in international standard EN 60529 (British BS EN 60529:1992, European IEC 60509:1989).

IP rating is composed of a two-digit number. The first digit represents protection against ingress of solid objects. The second digit represents protection against ingress of liquids.

## 1. Rakam: Katı cisimlere karşı koruma derecesi

1st Digit: Protection against solid objects



Korumasız  
No protection



Çapı 50 mm'den büyük katı cisimlere karşı korumalı  
Protected against solid objects over 50mm in diameter



Çapı 12,5 mm ve uzunluğu 80mm'den büyük katı cisimlere karşı korumalı  
Protected against solid objects over 12.5mm in diameter and 80mm in length



Çapı 2,5mm'den büyük katı cisimlere karşı korumalı  
Protected against solid objects with a diameter of 2.5mm or more

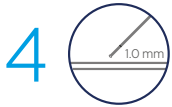

Çapı 1 mm'den büyük katı cisimlere karşı korumalı  
Protected against solid objects larger than 1.0mm



Toza karşı korumalı  
Limited protection against dust that may harm equipment



Toz geçirmez  
Totally protected against dust ingress.

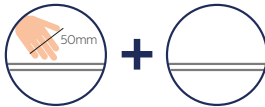

IP 2 0

Çapı 50 mm'den büyük katı cisimlere karşı korumalı  
Protected against solid objects over 50mm in diameter

Suya karşı korumasız  
No protection against liquids

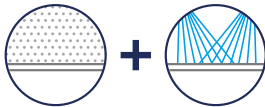

IP 6 5

Toz geçirmez  
Totally protected against dust ingress.

Yüksek basınçlı su püskürtmesine karşı her yönden korumalı  
Protected against high-pressure jets of directed water from any angle

## 2. Rakam: Sıvılara karşı koruma derecesi

2nd Digit: Protection against liquids



Korumasız  
No protection



Damlayan suya karşı korumalı  
Protected against vertically falling drops of water or condensation.



15°'lik açıya kadar eğik damlayan suya karşı korumalı  
Protected against water droplets deflected up to 15° from vertical



60°'lik açıya kadar püsküren suya karşı korumalı  
Protected against sprays of water from any direction, deflected up to 60° from vertical



Her yönden sıçrayan suya karşı korumalı  
Protected against splash water from all directions



Yüksek basınçlı su püskürtmesine karşı her yönden korumalı  
Protected against high-pressure jets of directed water from any angle



Şiddetli deniz dalgalarına karşı korumalı  
(Ör. gemi güvertesindeki cihazlar)  
Protected against severe sea waves

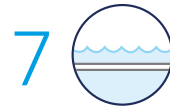

15-100cm arası en fazla 30dk boyunca suya daldırmanın etkilerine karşı korumalı  
Protected against full immersion for up to 30 minutes at depths between 15cm and 1 meter

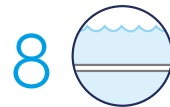

100cm üzeri derinlikte su altında bırakılmaya karşı korumalı  
Protection against extended immersion under higher pressure at greater depths



Yüksek basınçlı, yüksek sıcaklıktaki jet spreylerine, yıkamalara veya buharlı temizleme işlemlerine karşı koruma  
Protection against high-pressure, high-temperature jet sprays, wash-downs or steam-cleaning procedures

Aydınlatma sektöründe dış mekan uygulamalar için geliştirilen ürünlerde yaygın olarak rastlanan IP dereceleri; IP65, IP67 ve IP68'dir. Bu dereceler arasındaki farklar küçük ancak çok önemlidir :

IP65 = Toz geçirmez ve suya dayanıklı. Her yönden düşük basınçlı su püskürtmesine karşı korunmuştur.

IP65 aydınlatma ürünlerini suya batırmayın, su geçirmez değildir.

IP67 = Toz geçirmez ve suya daha dayanıklı. 15-100cm arası derinlikte en fazla 30dk boyunca geçici suya batırma olaylarına karşı korunmuştur.

IP67 aydınlatma ürünlerini uzun süre suya batırmayın, su geçirmez değildir.

IP68 = Toz ve su geçirmez. 100cm üzeri derinlikte suya batırma batırma olaylarına karşı kalıcı şekilde korunmuştur.

Let's review some most common IP65, IP67 and IP68 ratings used at outdoor LED lighting as follows,

IP65 = Dust tight and protected against water projected from a nozzle. Do not immerse in water. It is not protected against immersion in water.

IP67 = Dust tight and protected against immersion for 30 minutes at depths 150mm - 1000mm. Do not immerse in water. It is not protected against immersion in water.

IP68 = Dust tight and protected against complete, continuous submersion in water for 30 minutes at depths above 100cm.

## Koridor Fonksiyon Corridor Function



## Güç Faktörü

Çoğu üründe göz ardı edilen Güç Faktörü kavramı, birçok alanda olduğu gibi aydınlatma verimi anlamında da son derece önemli bir kavramdır.

Güç Faktörü, şebekeye bağlı aydınlatma ürününün veya herhangi bir yükün tükettiği gücün (gerçek güç, aktif güç, Watt) şebekeden çekilen görünen toplam güce ( Volt.Amper ) oranıdır. Görünen güç, aktif ve reaktif olarak iki parçalıdır. Reaktif taraf, kullanılmayan, şebekeye geri dönen ve şebekede gereksiz yüklemeye sebep olan yükür. Güç faktörü 0 ile 1 arasında bir değer alır. 1'e yakın değerler; düşük reaktif güçlü verimli enerji kullanımı, ülkemizin enerji kaynaklarının verimli kullanımı ve daha düşük elektrik faturası ödenmesi anlamına gelir. Elektrik kalite standartlarında, güç faktörünün genel olarak 0,9'dan iyi olması şart ve zorunludur.

$$PFC = \frac{\text{Gerçek tüketim gücü (W)}}{\text{Görünen tüketim gücü (VA)}} = \frac{\text{Aktif güç}}{\text{Aktif+Reaktif Güç}}$$

**PFC** 1,0 değerini görmüş olmak, gelen tüm enerjinin kullanıldığının ispatıdır.

Örnek olarak, **PFC** değerinin 0,80 olması %20 efektiflik oranı olduğunu ifade eder ki bu durum, gelen enerjinin %80'inin kullanıldığı, %20'nin ise endüktif yük olarak bilinen cihazlarda kullanılmadan yok olduğu anlamına gelmektedir.

Geleneksel aydınlatma ürünlerinin yerini LED ürünlerinin alacağını düşünürsek LED ürünleri için de **PFC**'nin önemi gün geçtikçe artacaktır.

Yüksek **PFC** değerli TELEtek® LED aydınlatma ürünlerini kullanmak hem enerji verimliliği sağlayacak hem de daha düşük rakamlı elektrik faturası ödemeye yardımcı olacaktır.

## Power Factor

The Power Factor concept that is ignored in most products, is an extremely important concept in lighting and other sectors as well .

Power Factor is the ratio of the amount of energy consumed by the electricity network-connected lighting product or any load power (actual power, active power, Watt) to the total apparent power (Volt.Amper) drawn from the network. The apparent power is in two parts, as active and reactive. Reactive side; unused, returning to the network and is the unnecessary load in the network. The power factor takes a value between 0 and 1. Values close to 1; means low reactive strong efficient energy.

$$PFC = \frac{\text{Actual consumption power (W)}}{\text{Apparent consumption power (VA)}} = \frac{\text{Active power}}{\text{Active + Reactive Power}}$$

**PFC** 1.0 is proof that all incoming energy is used.

For example, a **PFC** value of 0.80 is an expression of 20% efficiency, which means that 80% of the incoming energy is used, and 20% is destroyed in the devices as inductive load.

Considering that LED products will replace traditional lighting products, the importance of **PFC** for LED products will increase day by day.

Using TELEtek® LED lighting products with a high **PFC** value will provide energy efficiency and help you to pay a low-amount electricity bills.

## Notlar Notes

- 1) Siparişinize ait ışık rengi, ürün kod sonundaki XX tanımlı alan yerine aşağıdaki sayısal kısaltma ile ifade edilir.  
The color temperature of your order must be defined in the end of the product code instead of XX .
- 2) TELEtek ürünlerinde, Kore Menşeli EDISON marka LED kullanılmaktadır.  
TELEtek products are manufactured with EDISON brand LED of Korea origin .
- 3) TELEtek ürünlerinde, Ar&Ge laboratuvar tasarımı olan yerli sürücüler kullanılmaktadır.  
Drivers designed by our own R&D are used at our at lighting products.
- 4) Fiyatlarımıza %18 KDV ilave edilir.  
18% VAT will be added to the prices for sales within Turkey.
- 5) Teslim şekli : Kağıthane /İstanbul depo teslim. Nakliye masrafları alıcıya aittir.  
Incoterms is exworks. Transport charges are paid by the customer.
- 6) TELEtek Elektronik San.ve Tic.A.Ş. satışını yapmakta olduğu ürünlerde ve fiyatlarda değişiklik yapma hakkına sahiptir.  
TELEtek Elektronik San.veTic.A.Ş. reserves the right to change any product's price and specifications at any time without further notice.
- 7) Katalogda kullanılan tüm resimlerin yayın hakları TELEtek Elektronik San. ve Tic. A.Ş. firmasına aittir  
TELEtek Elektronik San.ve Tic.A.Ş. reserves the right of publication or reproduction for use of all images and graphic designs used in this catalogue.

## Referanslarımız Reference List



Borusan Otomotiv



invest

YDA

İZKA İNŞAAT



ATMACA

EXPRESS24

TAHİNCİOĞLU







Turkey

Discover  
the potential

Temiz enerji, Aydınlık gelecek

Clean energy, Bright future



Catalogue L04-2020

# TELEtek®

**TELEtek Elektronik San. ve Tic. A.Ş.**  
Merkez Mah. Ayazma Cad. No. 55/2  
34406 Kağıthane / İstanbul TURKEY  
T. +90 212 295 9700 F. +90 212 295 4243  
teletek@teletek.com.tr [www.teletek.com.tr](http://www.teletek.com.tr)



  
**KOSGEB**  
[www.kosgeb.gov.tr](http://www.kosgeb.gov.tr)  
Baskı Tarihi: 20.02.2020  
Baskı: PINARBAŞ Matbaası

[pinarbas.com.tr](http://pinarbas.com.tr)